

AZ95E18DAC

GE Zoneline® Cool/Electric Resistance Heat Vertical Air Conditioner 230-208 Volt

PERFORMANCE DATA AT 230 VOLT

- Cooling Capacity – 17,300 BTUh
- SEER2 - 12.0
- EER2 - 11.2

DIMENSIONS AND INSTALLATION INFORMATION (IN INCHES)

MINIMUM CLEARANCES:

FRONT-ACCESS CLOSETS

- Allow 3" in front of unit, Allow 3" on each side of unit.

SIDE-ACCESS CLOSETS

- Allow 5" in front of unit, Allow 3" on each side of unit.

REQUIRED COMPONENTS FOR INSTALLATION

- Drain Platform (RAVDPLAT)
- Plenum or Transition Plenum
- Exterior Grille
- Return Air Grille/ Access Panel
- Remote Thermostat
- Power Connection Kit

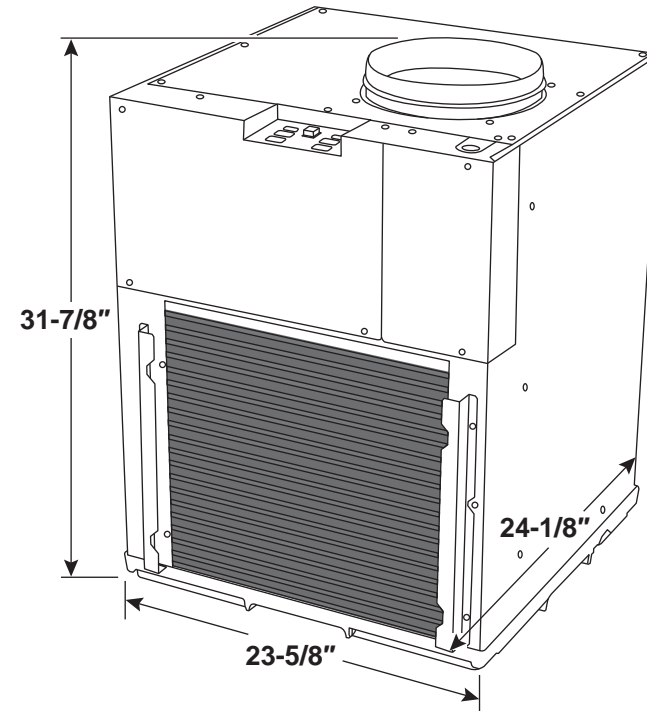

POWER CONNECTION REQUIREMENTS (RESISTANCE HEAT)					
230-208 VOLT	9,000/12,000 BTUh			18,000 BTUh	
POWER CONNECTION KIT	RAK315D	RAK320D	RAK330D	RAK320D	RAK330D
Heater Watts	2450/2004	3450/2822	5000/4089	3450/2822	5000/4089
MCA	15	20	30	20	30
Recommend Protective Device (MOCP)	15 amp time-delay fuse or breaker	20 amp time-delay fuse or breaker	30 amp time-delay fuse or breaker	20 amp time-delay fuse or breaker	30 amp time-delay fuse or breaker
*There is no 15 amp breaker option available for 18,000 BTUh models due to compliance with UL standard 60335-2-40					



GE APPLIANCES
a Haier company

For answers to your Monogram™, GE Café™, GE Profile™ or GE Appliances product questions, visit our website at GEAppliances.com or call GE Answer Center Service, 800.626.2000.

AZ95E18DAC

GE Zoneline® Cool/Electric Resistance Heat Vertical Air Conditioner 230-208 Volt

FEATURES AND BENEFITS

- **Insta-Platform™** – One-piece design fully integrates with the wall plenum and aligns for a tight seal. Eliminates need for a customized platform construction on site
- **Self-Contained Drainage System** – Easy installation and simple chassis removal while leaving plumbing completely intact
- **Fast-Connect Plumbing** – Thoughtful design enables platform build and rough plumbing completed in only minutes
- **Quick-Install Plenum** – Plenum is easily installed from the interior of building, without the need for exterior building access* (*caulking required)
- **Self-aligning, lock in place system** – Perfect fit and mistake proof when the chassis is placed on the platform
- **Onboard Diagnostics** – Electronic controls give clear and fast diagnostics data and fault codes, for quick and easy notifications
- **Anti-Corrosion Design** – Exclusive rust-proof basepan and bulkhead provide another level of corrosion protection
- **Ultra-Quiet** – Delivers quiet cooling power with a smooth sound for a good night's sleep
- **SmartHQ WIFI capability** – An optional WiFi module gives property managers the ability to oversee units, increasing productivity and enhancing guests' experience

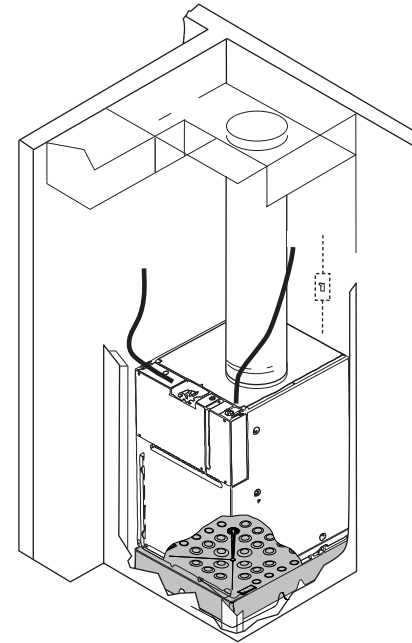

ZONELINE® WARRANTY*

WHAT IS COVERED:

LIMITED ONE-YEAR WARRANTY

For one year from date of original purchase, we will provide, free of charge, parts and service labor on site to repair or replace any part of the Zoneline that fails because of a manufacturing defect.

LIMITED ADDITIONAL FOUR-YEAR WARRANTY

For an additional four years from the date of original purchase, we will provide, free of charge, parts and on-site service labor to repair or replace any part of the sealed refrigerating system (the compressor, condenser, evaporator and all connecting tubing) that fails because of a manufacturing defect.

*See Written Warranty For Details

LIMITED 2ND THROUGH 5TH YEAR PARTS WARRANTY

For the second through the fifth year from date of original purchase, GE Appliances will provide, free of charge, parts that fail as a result of a manufacturing defect. Parts covered are fan motors, switches, heater, heater protectors, compressor overload, solenoids, circuit boards, auxiliary controls, thermistors, frost controls, capacitors and varistors. This is a limited parts-only warranty, and does not include labor or transportation to and from the service shop.

All warranty service will be provided by our Factory Service Centers or by our authorized Customer Care® servicers during normal working hours.



GE APPLIANCES
a Haier company